



**ELECTRICAL
SUPPORT
SYSTEMS
CATALOGUE**





Contents

1 Electrical Supports

Perforated Cable Tray & Accessories.....	Page 1
Ladder Tray & Accessories.....	Page 2-4
Cable Mesh & Cable Duct	Page 5
Covers & Barrier Strip.....	Page 6
Cable Ladder.....	Page 7-8
Electrical Meter Boxes, Din Kits & Foot Entry Bends...	Page 9
J Hooks, Grommets & Flange Clips.....	Page 10
Purlin Clips, Beam Clamps & Mounting Plates	Page 11-12
Caddy Beam Clamps & Conduit Clips.....	Page 13
Conduit, Couplings & Accessories.....	Page 14

2 Channel & Accessories

Channel Profiles.....	Page 15
Cantilevers, Angle & Joiners	Page 16
Channel Nuts, Closure Strip, Caps & Trolleys.....	Page 17
Channel Fittings	Page 18

3 Threaded Consumables

Vertigo Hangers	Page 19
Masonry Fasteners.....	Page 20
Threaded Rod, Nuts, Washers & Coach Screws	Page 21
Set Screws, Cup Heads & Pan Pozis	Page 22
Tek Screws & Drill Bits.....	Page 23
Rivets & Tools	Page 24

1. Electrical Supports

Perforated Cable Tray & Accessories

Caddy perforated cable tray is a light duty cable support system. It has pre-punched slots 8mm x 12.7mm for cable tie fixing. It is manufactured from galvabond material.

TRAY

Part #	Description
CTP-075-2.4	75mm x 2.4m
CTP-100-2.4	100mm x 2.4m
CTP-150-2.4	150mm x 2.4m
CTP-225-2.4	225mm x 2.4m
CTP-300-2.4	300mm x 2.4m
CTP-450-2.4	450mm x 2.4m
CTP-600-2.4	600mm x 2.4m



TEE

Part #	Description	Part #	Description
CTP-075-T	75mm Tee	CTP-075-B90	75mm Bend
CTP-100-T	100mm Tee	CTP-100-B90	100mm Bend
CTP-150-T	150mm Tee	CTP-150-B90	150mm Bend
CTP-225-T	225mm Tee	CTP-225-B90	225mm Bend
CTP-300-T	300mm Tee	CTP-300-B90	300mm Bend
CTP-450-T	450mm Tee	CTP-450-B90	450mm Bend
CTP-600-T	600mm Tee	CTP-600-B90	600mm Bend

BEND – 90 DEGREE



INTERNAL RISER

Part #	Description	Part #	Description
CTP-075-IR	75mm Int	CTP-075-ER	75mm Ext
CTP-100-IR	100mm Int	CTP-100-ER	100mm Ext
CTP-150-IR	150mm Int	CTP-150-ER	150mm Ext
CTP-225-IR	225mm Int	CTP-225-ER	225mm Ext
CTP-300-IR	300mm Int	CTP-300-ER	300mm Ext
CTP-450-IR	450mm Int	CTP-450-ER	450mm Ext
CTP-600-IR	600mm Int	CTP-600-ER	600mm Ext

EXTERNAL RISER

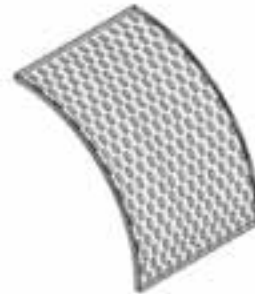

CROSS

Part #	Description	Part #	Description
CPT-075-X	75mm Cross	CTP-300-X	300mm Cross
CTP-100-X	100mm Cross	CTP-450-X	450mm Cross
CTP-150-X	150mm Cross	CTP-600-X	600mm Cross
CTP-225-X	225mm Cross		



Also available "to order" in HDG FINISH, STAINLESS STEEL or ALUMINIUM.

1. Electrical Supports

CT3 and CT5 Ladder Tray

The versatile and cost effective cable support system. Manufactured from galvabond material, CT3 & CT5 ladder tray is lightweight and easy to install.

It is complemented by the full range of accessories for fast on-site fabrication of bends, tees etc.

CT3 has 45mm high sides, CT5 has 75mm high sides.

Load rated to 116kg for CT3 and 230kg for CT5 based on a 1.5m span between support points.

It is the strongest in its class.

CT3 LADDER TRAY

Part #	Description
CT3-150-3	150mm x 3m
CT3-300-3	300mm x 3m
CT3-450-3	450mm x 3m
CT3-600-3	600mm x 3m



LOAD RATING AND DEFLECTION

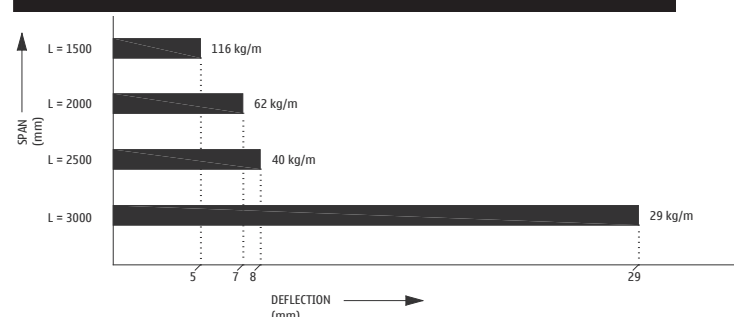

CT5 LADDER TRAY

Part #	Description
CT5-150-3	150mm x 3m
CT5-300-3	300mm x 3m
CT5-450-3	450mm x 3m
CT5-600-3	600mm x 3m



LOAD RATING AND DEFLECTION

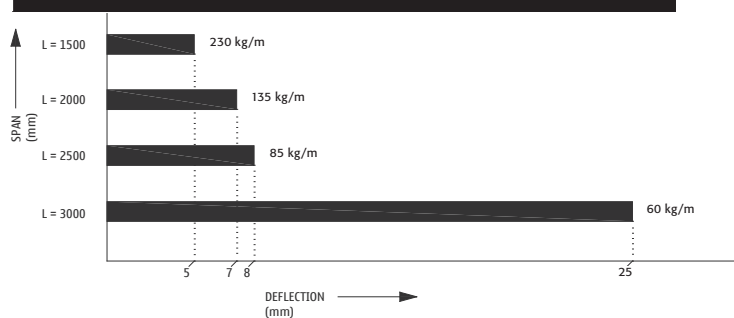

Also Available "to order" in HDG Finish.

1. Electrical Supports

Ladder Tray

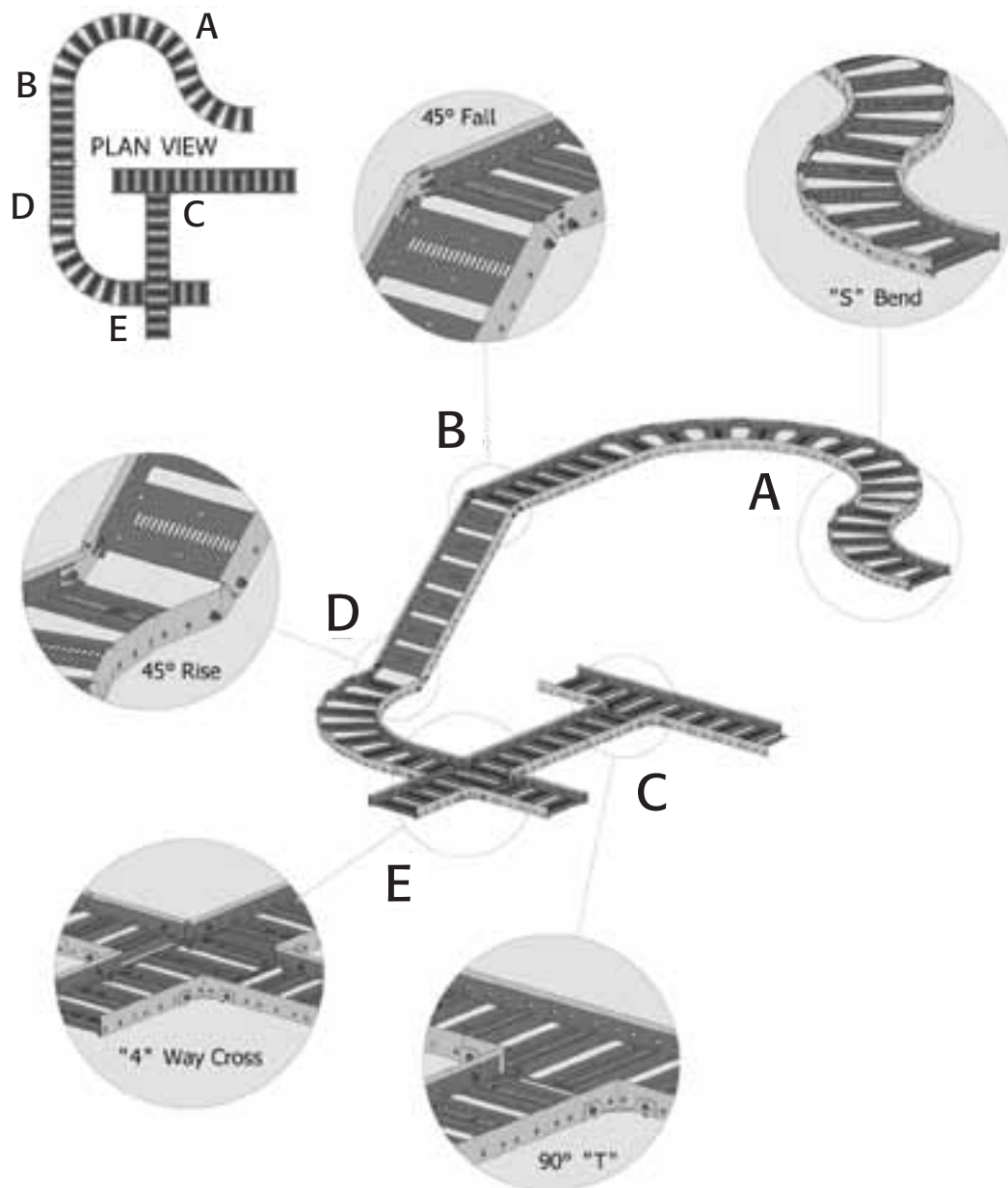

Dia.	Connection Type:	Connector Code	N° Required	Flanged Nut & Bolt Description	N° Required
A	"S" BEND	CT3/BS	1	CT3/5 Bolt Nut	6
B	45° ↘	CT3/LP	2	CT3/5 Bolt Nut	4
C	90° T	CT3-TX	2	CT3/5 Bolt Nut	8
D	45° ↗	CT3/LP	2	CT3/5 Bolt Nut	4
E	90° T	CT3-TX	4	CT3/5 Bolt Nut	16

Also Available "to order" in HDG Finish.

1. Electrical Supports

Ladder Tray Accessories

A full range of accessories available for manufacture of Bends, Tees, Risers & Crosses.

CT3-SPLICE PLATE



CT3-LINK PLATE



CT3-TX BRACKET



CENTER HOLD DOWN CLAMP

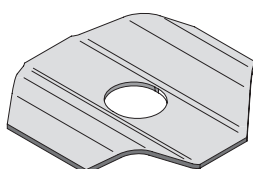

CT3-BEND SIDE



CT3-HOLD DOWN CLAMP



CT5-SPLICE PLATE



CT5-LINK PLATE



CT5-TX BRACKET



CT5-BEND SIDE



CT5-HOLD DOWN CLAMP



CT3/CT5 BOLT NUT SET



Also Available "to order" in HDG Finish.

1. Electrical Supports

Cable Mesh

The new Caddy Cable Mesh support system is manufactured from 5mm ZP steel wire, very lightweight with a safe edge for cable protection. With 50mm high sides & 50 x 100mm grid, it supports the cable evenly and allows easy dropout of cables without cutting the tray.

There is a full complement of accessories for quick and easy on-site manufacture of Bends, Tees & Risers.

It is the perfect answer for retro-fit applications.

CABLE MESH

Part #	Description
4411050	50mm x 3m
4411100	100mm x 3m
4411150	150mm x 3m
4411200	200mm x 3m
4411300	300mm x 3m
4411400	400mm x 3m
4411500	500mm x 3m
4411600	600mm x 3m
44131	Universal Bracket
44132	Rapid fit Connector
44133	Rapid Splice Plate
44134	Bendable Coupler 1200mm
44135	CLU Lighting Support
44136	U40 Hanging Clamp 9mm
44170011	KBT Wire Basket Tray Clip

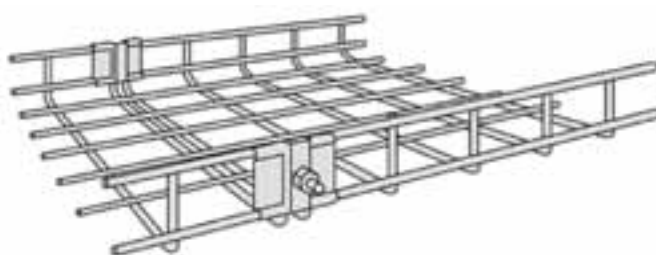

Caddy Cable Duct with Screw On Lid

* Not Stocked - to order only

Caddy Cable Duct is manufactured from galvabond material in 2.4 m lengths. The body is fitted with 8 unique threaded inserts for ease of installation of the lid and a joggled end provides a built in splice connection.

It is used extensively across the industry for the support and protection of light cables. There is a full complement of Risers, Tees & Bends available.

CADDY CABLE DUCT

Part #	Description
44171050	50 x 50 x 2.4m GB c/w Lid
44171075	75 x 75 x 2.4m GB c/w Lid
44171100	100 x 100 x 2.4m GB c/w Lid
44171150	150 x 150 x 2.4m GB c/w Lid
44172050	50 x 50 Bend or Riser GB c/w Lid
44172075	75 x 75 Bend or Riser GB c/w Lid
44172100	100 x 100 Bend or Riser GB c/w Lid
44172150	150 x 150 Bend or Riser GB c/w Lid
44173050	50 x 50 Tee GB c/w Lid
44173075	75 x 75 Tee GB c/w Lid
44173100	100 x 100 Tee GB c/w Lid
44173150	150 x 150 Tee GB c/w Lid

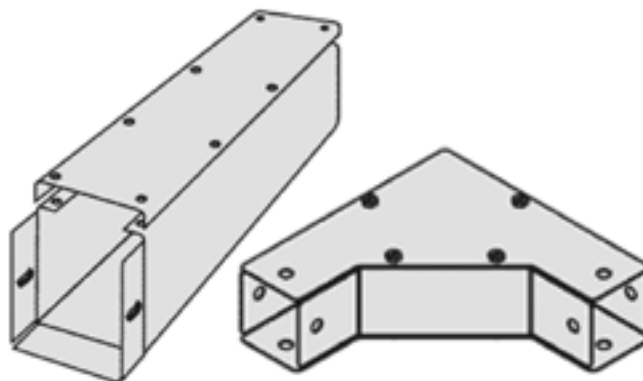

1. Electrical Supports

Cover and Barrier Strip for Ladder Tray and Ladder

COVER

We offer a full range of covers to suit all CT3/5 Ladder Tray and Cable Ladder.

Manufactured from galvabond material as standard and in 3 m lengths.

It is available in flat or peaked finish.

Covers are fixed in position using cover clips or simply with a tek screw into the ladder rail.

Part #	Description
47CGF155	155mm x 3m Flat Cover Galvabond
47CGF305	305mm x 3m Flat Cover Galvabond
47CGF455	455mm x 3m Flat Cover Galvabond
47CGF605	605mm x 3m Flat Cover Galvabond

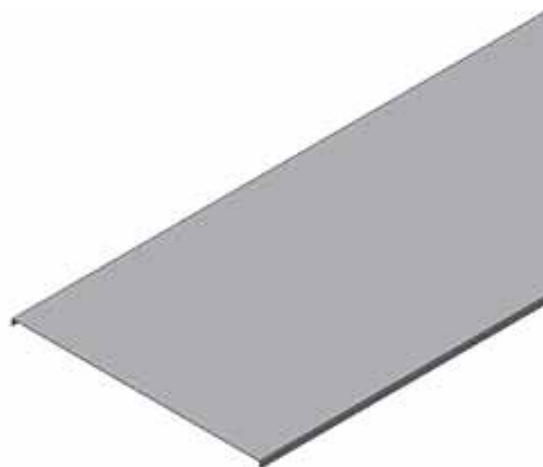

Also available "to order" in HDG FINISH, STAINLESS STEEL or ALUMINIUM.

BARRIER STRIP

Barrier (divider) Strip to suit CT3/5 Ladder Tray and Cable Ladder.

Manufactured from Galvabond material as standard and in 3 m lengths. Fixed in position with M6x20 pan screws and channel nuts through the pre punched slots in the base of the divider strip.

Part #	Description
48N1DS	CT3 & N1 Divider Strip 3m
48N2/3DS	CT5 & N2/3 Divider Strip 3m

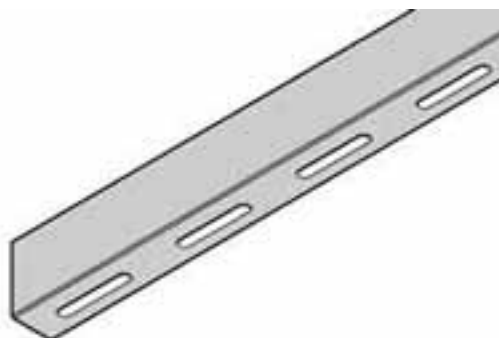

Also available "to order" in STAINLESS STEEL or ALUMINIUM.

1. Electrical Supports

NEMA2 Cable Ladder

NEMA2 is a MEDIUM duty cable ladder in 6 m lengths.

Standard finish is HDG.

It has 93mm high sides with a cable laying depth of 75mm.

Standard rung spacing is 300mm with pre punched slots for easy cable fixing.

Load rated to 470kg based on a 3.0m span between support points.

Rail In is the stocked type and all accessories are standard 450 radius.

Rail Out and other radius accessories available to order.

N2 HDG LADDER

Part #	Description
48N2L150NH	150mm x 6m
48N2L300NH	300mm x 6m
48N2L450NH	450mm x 6m
48N2L600NH	600mm x 6m

N2 ACCESSORIES

Part #	Description
48N2SH	N2 Splice Plate
48SBH	N2 Splice Bolt
48SNH	N2 Splice Nut
48N2HSKH	N2 Hinged Horizontal Splice
48N2VSKH	N2 Hinged Vertical Splice
48N2HDUH	N2 Hold Down Bracket

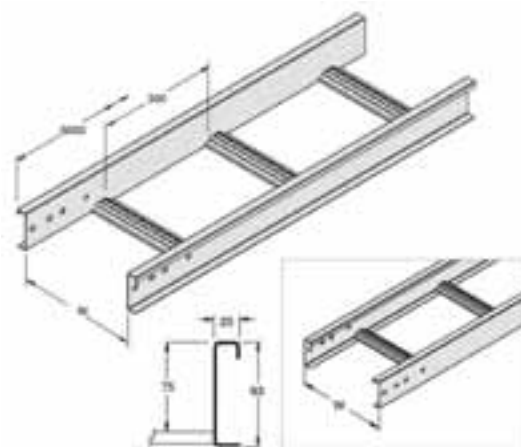

BEND

Part #	Description
48N2B1504H	N2 Bend 900 450R 150w
48N2B3004H	N2 Bend 900 450R 300w
48N2B4504H	N2 Bend 900 450R 450w
48N2B6004H	N2 Bend 900 450R 600w

EXTERNAL RISER

Part #	Description
48N2ER1504H	N2 Ext Riser 450R 150W
48N2ER3004H	N2 Ext Riser 450R 300W
48N2ER4504H	N2 Ext Riser 450R 450W
48N2ER6004H	N2 Ext Riser 450R 600W

CROSS

Part #	Description
48N2C1504H	N2 Cross 450R 150W
48N2C3004H	N2 Cross 450R 300W
48N2C4504H	N2 Cross 450R 450W
48N2C6004H	N2 Cross 450R 600W

INTERNAL RISER

Part #	Description
48N2IR1504H	N2 Int Riser 450R 150W
48N2IR3004H	N2 Int Riser 450R 300W
48N2IR4504H	N2 Int Riser 450R 450W
48N2IR6004H	N2 Int Riser 450R 600W

TEE

Part #	Description
48N3T1504H	N2 Tee 450R 150W
48N3T3004H	N2 Tee 450R 300W
48N3T4504H	N2 Tee 450R 450W
48N3T6004H	N2 Tee 450R 600W

Also available "to order" in STAINLESS STEEL or ALUMINIUM.

1. Electrical Supports

NEMA3 Cable Ladder

NEMA3 is a HEAVY duty cable ladder in 6 m lengths.

Standard finish is HDG.

It has 130mm high sides with a cable laying depth of 112mm.

Standard rung spacing is 300mm with pre punched slots for easy cable fixing.

Load rated to 573kg based on a 3.0mtr span between support points.

Rail In is the stocked type and all accessories are standard 450 radius.

Rail Out and other radius accessories available to order.

N3 HDG LADDER

Part #	Description
48N3L150NH	150mm x 6m
48N3L300NH	300mm x 6m
48N3L450NH	450mm x 6m
48N3L600NH	600mm x 6m

N3 ACCESSORIES

Part #	Description
48N3SH	N3 Splice Plate
48SBH	N3 Splice Bolt
48SNH	N3 Splice Nut
48N3HSKH	N3 Hinged Horizontal Splice Plate
48N3VSKH	N3 Hinged Vertical Splice Plate
48N3H DUH	N3 Hold Down Bracket

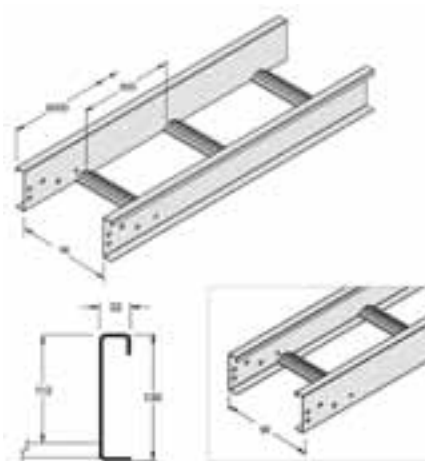

BEND

Part #	Description
48N3B1504H	N3 Bend 90D 450R 150W
48N3B3004H	N3 Bend 90D 450R 300W
48N3B4504H	N3 Bend 90D 450R 450W
48N3B6004H	N3 Bend 90D 450R 600W

INTERNAL RISER

Part #	Description
48N3IR1504H	N3 Int Riser 450R 150W
48N3IR3004H	N3 Int Riser 450R 300W
48N3IR4504H	N3 Int Riser 450R 450W
48N3IR6004H	N3 Int Riser 450R 600W

EXTERNAL RISER

Part #	Description
48N3ER1504H	N3 Ext Riser 450R 150W
48N3ER3004H	N3 Ext Riser 450R 300W
48N3ER4504H	N3 Ext Riser 450R 450W
48N3ER6004H	N3 Ext Riser 450R 600W

TEE

Part #	Description
48N3T1504H	N3 Tee 450R 150W
48N3T3004H	N3 Tee 450R 300W
48N3T4504H	N3 Tee 450R 450W
48N3T6004H	N3 Tee 450R 600W

CROSS

Part #	Description
48N3C1504H	N3 Cross 450R 150W
48N3C3004H	N3 Cross 450R 300W
48N3C4504H	N3 Cross 450R 450W
48N3C6004H	N3 Cross 450R 600W

Also available "to order" in STAINLESS STEEL or ALUMINIUM.

1. Electrical Supports

Electrical Meter Boxes, Din Kits & Foot Entry Bends

ELECTRICAL METER BOXES

Part #	Description	Dimensions
49A4	Electrical Meter Box Pole Mounted GB	490 x 510 x 255
49A4-1	Electrical Meter Box Recessed GB	490-470 x 510 x 255
49A5	Electrical Meter Box Half GB	265 x 510 x 255
49A4/WL	Meter Box Pole Mounted C/W Window & Lock	
49A4-DW	Meter Box Door only with Window	
49A4-D	Meter Box Standard Door Only	
49CL	Meter Box Cam Lock only	
49PBS	Pole Box Saddles GB(Pair 2)	



DIN KITS

Part #	Description
49DK08	Din Kit Box 1 Window GB 8 Pole
49DK16	Din Kit Box 2 Window GB 16 Pole
49DK24	Din Kit Box 3 Window GB 24 Pole
49DK21	Din Kit Box 1 Window P/C Blue 21 Pole



FOOT ENTRY BENDS

Part #	Description
49FEB25	25mm Foot Entry Bend GB
49FEB32	32mm Foot Entry Bend GB
49FEB40	40mm Foot Entry Bend GB



1. Electrical Supports

J Hooks, Grommets & Flange Clips

CAT 32HP

Part # / Description	A mm	Ø mm	Box Quantity
32CAT32HP		50	60

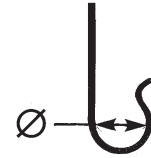

CAT 4Z34/6Z34

Part # / Description	A mm	Ø mm	Box Quantity
32CAT32HP4Z34	M4-M8	50	60
32CAT32HP6Z34	M8-M12	50	60



ESGP GROMMET

Part #	Description	A mm	Ø mm	Box Quantity
31ESGP	Anti Rattle Grommet		34	100

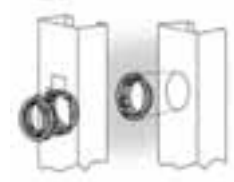

MSP PUNCH

Part #	Description	A mm	Ø mm	Box Quantity
31MSP20	Metal Stud Punch		34	1

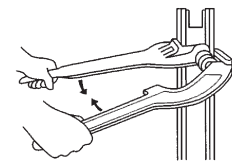
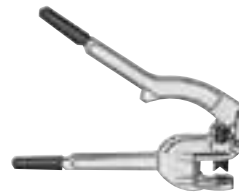

H-CLIP

Part # / Description	A mm	Ø mm	Box Quantity
312H4	2-3	N/A	100
314H24	3-8	N/A	100
314H58	8-14	N/A	100
314H912	14-20	N/A	100

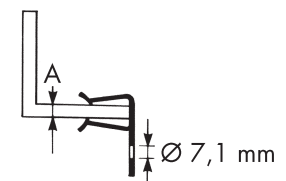

H-CT CLIP

Part # / Description	A mm	Ø mm	Box Quantity
312H4CT	2-3	N/A	100
314H24CT	3-8	N/A	100
314H58CT	8-14	N/A	100
314H912CT	14-20	N/A	100

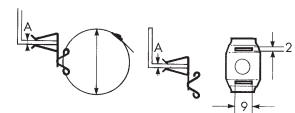

APC CLIP

Part # / Description	A mm	Ø mm	Box Quantity
31APC	1.5-4	N/A	100

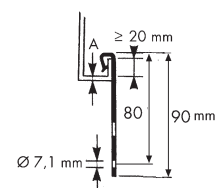

1. Electrical Supports

Purlin Clips, Mounting Plates & Beam Clamps

D1 CLIPS

Part # / Description	A mm	Ø mm	Box Quantity
34D1M08	≤4	9	100
34D1M10	≤4	11	100
34D1M12	≤4	13	100



E2 CLIPS

Part # / Description	A mm	Ø mm	Box Quantity
34E2M08-TI	≤4	M8	100
34E2M10-TI	≤4	M10	100
34E2M12-TI	≤4	M12	100



CMP PLATE

Part # / Description	A mm	Ø mm	Box Quantity
34CMPM08-TI	N/A	M8	100
34CMPM10-TI	N/A	M10	100
34CMPM12-TI	N/A	M12	100



VMP PLATE

Part # / Description	A mm	Ø mm	Box Quantity
34VMPM08-TI	N/A	M8	100
34VMPM10-TI	N/A	M10	100
34VMPM12-TI	N/A	M12	100



MMP PLATE

Part # / Description	A mm	Ø mm	Box Quantity
34MMPM10	N/A	M10	100



HMP PLATE

Part # / Description	A mm	Ø mm	Box Quantity
34HMPM10	N/A	M10	100



1. Electrical Supports

Purlin Clips, Mounting Plates & Beam Clamps

TKN CLAMPS Z/P

Part # / Description	A mm	Ø mm	Box Quantity
34TKN8	18	9	100
34TKN10	20	11	100
34TKN12	26	13	80



310 CLAMPS

Part # / Description	A mm	Ø mm	Box Quantity
34BTK10	32	M10	100
34BTK12	32	M12	50



HB2 CLAMPS

Part # / Description	A mm	Ø mm	Box Quantity
34HB2-3 (HDG)	≤24	N/A	50
34HB2 (ZP)	≤24	N/A	50



WEDGE NUTS

Part # / Description	A mm	Ø mm	Box Quantity
34HW6		M6	100
34HW8		M8	100
34HW10		M10	100
34HW12		M12	100

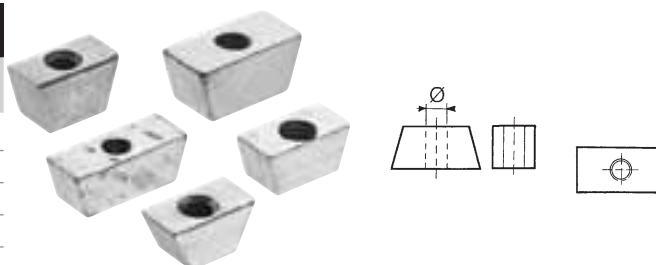

VF14 CLIPS

Part # / Description	A mm	Ø mm	Box Quantity
31VF14	1.5-6		100
31VF14M6TI	1.5-6	M6	100
31VF14M8TI	1.5-6	M8	100
31VF14M10TI	1.5-6	M10	100

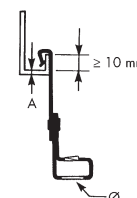

1. Electrical Supports

Beam Clamps & Conduit Clips

CIS CLAMP HDG

Part # / Description	A mm	Ø mm	Box Quantity
333CIS20-3	<= 20	M6 X 25	100
333CIS30-3	20-30	M8 X 30	100
333CIS45-3	30-45	M8 X 30	50

CISR CLIPS

Part # / Description	A mm	Ø mm	Box Quantity
333CISR17-3		16-20	200
333CISR21-3		20.4-25	100
333CISR28-3		26.9-31.8	50
333CISR42-3		40-44.5	50
333CISR48-3		47-51	50
333CISR60-3		59.2-63.5	25



CIS CLAMPS SS

Part # / Description	A mm	Ø mm	Box Quantity
332CIS20-2	<= 20	M6 X 25	100
332CIS30-2	20-30	M8 X 30	100
332CIS45-2	30-45	M8 X 30	50

CISR CLIPS SS

Part # / Description	A mm	Ø mm	Box Quantity
332CISR17-2		16-20	200
332CISR21-2		20.4-25	100
332CISR28-2		26.9-31.8	50
332CISR42-2		40-44.5	50
332CISR48-2		47-51	50
332CISR60-2		59.2-63.5	25



FLANGE PROTECTOR

Part # / Description	A mm	Ø mm	Box Quantity
332P6		M6	100
332P8		M8	100



1. Electrical Supports

Screwed Hot Dip Galvanised Conduit Class 4. AS/NZ 2053.7

CONDUIT-HOT DIP GALV (4M LENGTHS)

Part #	Size	Bundle	Weight/Bundle
29SC20HDG	20mm	10 Lengths	33kg
29SC25HDG	25mm	7 Lengths	33.6kg
29SC32HDG	32mm	5 Lengths	31kg
29SC40HDG	40mm	3 Lengths	24kg
29SC50HDG	50mm	3 Lengths	33kg



All Conduit supplied with one Coupling – Standard 4 m lengths – Both ends threaded

COUPLINGS

Part #	Size	Box Quantity	Weight/Box
29C20HDG	20mm	50	2.5kg
29C25HDG	25mm	50	3.5kg
29C32HDG	32mm	50	5.5kg
29C40HDG	40mm	50	7.5kg
29C50HDG	50mm	50	8kg



CHANNEL CLIPS – SS

Part #	Description	Ø mm
3582019	EC2028-2	19mm
3582025	EC2030-2	25mm
3582032	EC2032-2	32mm
3582038	EC2034-2	38mm
3582051	EC2038-2	51mm

CHANNEL CLIPS – HDG

Part #	Description	Ø mm
3583019	EC2028-3	19mm
3583025	EC2030-3	25mm
3583032	EC2032-3	32mm
3583038	EC2034-3	38mm
3583051	EC2038-3	51mm



CHANNEL CLIPS – ZP

Part #	Description	Ø mm
3581019	EC2028-1	19mm
3581025	EC2030-1	25mm
3581032	EC2032-1	32mm
3581038	EC2034-1	38mm
3581051	EC2038-1	51mm

CONDUIT BENDER

Part #	Description	Ø mm
29CB	Steel Conduit Bender	20,25,32MM



2. Channel and Accessories

Channel Profiles

HEAVY DUTY 2.5MM THICKNESS

Part #	Size mm	Finish	Box Quantity
36ES1000-6	41 x 41 x 6 Mtr	HDG	1
36ES3300-6	41 x 21 x 6 Mtr	HDG	1
36ES1000-3	41 x 41 x 3 Mtr	HDG	1
36ES3300-3	41 x 21 x 3 Mtr	HDG	1
36ES5500-6	41 x 62 x 6 Mtr	HDG	1
36ES1001-6	41 x 82 x 6 Mtr	HDG	1
36ES1000-GB	41 x 41 x 6 Mtr	G/Bond	1
36ES3300-GB	41 x 21 x 6 Mtr	G/Bond	1
36ESS1000-6	41 x 41 x 6 Mtr	S/Steel	1
36ESS3300-6	41 x 21 x 6 Mtr	S/Steel	1

HEAVY DUTY 2.5MM THICKNESS SLOTTED

Part #	Size mm	Finish	Box Quantity
36ES1000T-6	41 x 41 x 6 Mtr	HDG	1
36ES3300T-6	41 x 21 x 6 Mtr	HDG	1
36ES1000T-3	41 x 41 x 3 Mtr	HDG	1
36ES3300T-3	41 x 21 x 3 Mtr	HDG	1



ES1000



ES3300



ES1000T



ES3300T

LIGHT DUTY 1.6MM THICKNESS

Part #	Size mm	Finish	Box Quantity
36ES2000-6	41 x 41 x 6 Mtr	G/Bond	1
36ES4000-6	41 x 21 x 6 Mtr	G/Bond	1



ES4000

Max: 1.25kg/m

LIGHT DUTY 1.6MM THICKNESS SLOTTED

Part #	Size mm	Finish	Box Quantity
36ES2000T-6	41 x 41 x 6 Mtr	G/Bond	1
36ES4000T-6	41 x 21 x 6 Mtr	G/Bond	1



ES2000T



ES4000T

FIBREGLASS

Part #	Size mm	Finish	Box Quantity
36FG1000-3	41 x 41 x 3 Mtr	Fibreglass	1
36FG3300-6	41 x 21 x 6 Mtr	Fibreglass	1

ALUMINUM

Part #	Size mm	Finish	Box Quantity
36ES2000AL	41 x 41 x 6 Mtr	Aluminum	1
36ES4000AL	41 x 21 x 6 Mtr	Aluminum	1

2. Channel and Accessories

Cantilevers, Angle & Joiners

CADDY CANTILEVER BRACKETS STANDARD (NO BRACE)

Part #	Size mm	Finish	Box Quantity
36CL150	150mm Long	HDG	1
36CL300	300mm Long	HDG	1
36CL450	450mm Long	HDG	1
36CL600	600mm Long	HDG	1
36CL750	750mm Long	HDG	1



CADDY CANTILEVER BRACKETS BRACED TYPE

Part #	Size mm	Finish	Box Quantity
36CL320B	320mm Long	HDG	1
36CL470B	470mm Long	HDG	1
36CL640B	640mm Long	HDG	1
36CL780B	780mm Long	HDG	1

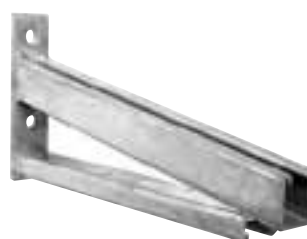

SLOTTED ANGLE ZP

Part #	Description	Length	Box Quantity
36A3030	30 X 30 Slotted Angle	3m	10
36A5050	50 X 50 Slotted Angle	3m	10



CADDY JOINER EXTERNAL ZP

Part #	Description	Box Quantity
36J2377	External Channel Joiner	50

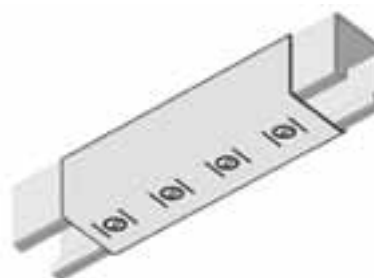

CADDY JOINER INTERNAL ZP

Part #	Description	Box Quantity
36J922	Internal Channel Joiner	50

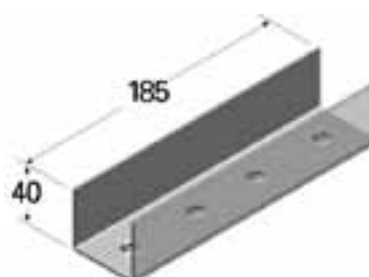

2. Channel and Accessories

Channel Nuts, Closure Strip, Caps & Trolleys

Channel Nuts also available in HDG and SS finishes.

CHANNEL NUTS (NO SPRING)

Part #	Size mm	Finish	Box Quantity
36NT06	M6 Trunking Nuts	ZP	100
36NN06	M6 No Spring Nuts	ZP	100
36NN08	M8 No Spring Nuts	ZP	100
36NN10	M10 No Spring Nuts	ZP	100
36NN12	M12 No Spring Nuts	ZP	100
36NN16	M16 No Spring Nuts	ZP	100



CHANNEL NUTS (SHORT SPRING)

Part #	Size mm	Finish	Box Quantity
36NS06	M6 Short Spring Nuts	ZP	100
36NS08	M8 Short Spring Nuts	ZP	100
36NS10	M10 Short Spring Nuts	ZP	100
36NS12	M12 Short Spring Nuts	ZP	100
36NS16	M16 Short Spring Nuts	ZP	100



CHANNEL NUTS (LONG SPRING)

Part #	Size mm	Finish	Box Quantity
36NL06	M6 Long Spring Nuts	ZP	100
36NL08	M8 Long Spring Nuts	ZP	100
36NL10	M10 Long Spring Nuts	ZP	100
36NL12	M12 Long Spring Nuts	ZP	100
36NL16	M16 Long Spring Nuts	ZP	100



PRE-MOUNTED CHANNEL NUTS

Part #	Size mm	Finish	Box Quantity
36NP08040	M8 x 40 Pre-Mounted Nut	ZP	100
36NP10040	M10 x 40 Pre-Mounted Nut	ZP	100



CLOSURE STRIP

Part #	Size mm	Finish	Box Quantity
36313309	Grey Suit 41mm Channel	Plastic	1
36313311	Aluminium suit 41mm Channel	Aluminum	1



CHANNEL END CAPS

Part #	Size mm	Finish	Box Quantity
362240	Grey Suit 41mm Channel	Plastic	100
3624240	Grey Suit 21mm Channel	Plastic	100



CHANNEL TROLLEYS

Part #	Size mm	Finish	Box Quantity
362749	2 Wheel Suit 41mm Channel	ZP	25
362950	4 Wheel Suit 41mm Channel	ZP	25

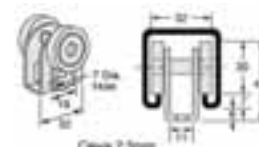

2. Channel and Accessories

Channel Fittings

CADDY CHANNEL FITTINGS

Part #	Description	Box Quantity
36387495	ZEA111	10
36387500	ZEA100	10
36387520	ZEA102	10
36387530	ZEA103	10
36387540	ZEA104	10
36387560	ZEA106	10
36387570	ZEA107	10
36387580	ZEA108	10
36387590	ZEA109	10
36387450	ZEA110	10
36388270	ZGA501	10
36387740	ZSA301	10
36387701	ZTA601	10
36387702	ZTA602	10
36388080	ZTA605	10
36313270	ZT606	10
36387750	ZUA400	10
36387760	ZUA401	10
36387600	ZWA200	100
36387620	ZWA202	10
36387650	ZWA205	10
36387670	ZWA207	10
36387690	ZWA209	10
36387890	ZWA214	10
36387900	ZWA215	10
36388400	ZZA701	10
36387720	ZZA702	10
36313870	ZZ704	10
36P11	P11000HD	10
36P13	P13000HD	10



ZTA601



ZTA605



ZZA704



ZEA100/111



ZEA102



ZEA104



ZEA106



ZEA107



ZEA108



ZEA109



ZEA110



ZGA501



ZSA301



ZUA400



ZWA214



ZZA701



ZZA702



ZWA215



ZWA200



ZT606



ZUA401



ZWA200



ZWA202



P11000HD

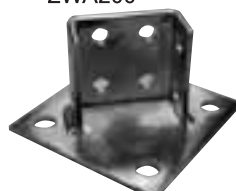

P13000HD



ZWA205



ZWA207



ZWA209

3. Threaded Consumables

Vertigo Hangers

For fixing direct to concrete, timber & steel trusses.

Vertical or side hangers.

Vertigo is a one-piece all steel threaded rod hanger. It can be installed into steel truss, purlins, timber joists as well as concrete. Supports 6mm - 10mm threaded rod.

Simply insert the required Vertigo into the appropriate driver & install using a cordless drill.

VERTICAL HANGER FOR STEEL

Part #	Description	Box Quantity
186308	8mm Rod Hanger	100
186310	10mm Rod Hanger	100



SIDE HANGER FOR STEEL

Part #	Description	Box Quantity
186208	8mm Rod Hanger	100
186210	10mm Rod Hanger	100



VERTICAL HANGER FOR TIMBER

Part #	Description	Box Quantity
186508	8mm Rod Hanger	100
186510	10mm Rod Hanger	100



SIDE HANGER FOR TIMBER

Part #	Description	Box Quantity
186620	10mm Rod Hanger	100



VERTICAL HANGER FOR CONCRETE

Part #	Description	Box Quantity
186110	10mm Rod Hanger	100

DRIVING SOCKETS

Part #	Description	Box Quantity
186000	Timber/Steel "Red"	1
186001	Concrete "Blue"	1



3. Threaded Consumables

Masonry Fasteners

STRIKE ANCHORS

Part #	Anchor Dia x Length mm	Drill Hole Dia mm	Box Quantity
41ESA0850	8 x 50	8	60
41ESA1050	10 x 50	10	40



SLEEVE ANCHOR HEX NUT (DYNABOLT) ZP

Part #	Anchor Dia x Length mm	Drill Hole Dia mm	Box Quantity
41485010	6.5 x 25	6.5	100
41485050	6.5 x 36	6.5	100
41485250	8 x 40	8	100
41485300	8 x 65	8	100
41485440	10 x 40	10	100
41485450	10 x 50	10	100
41485475	10 x 75	10	50
41485600	10 x 97	10	50
41485760	12 x 60	12	50



DROP IN ANCHOR, FLANGED TYPE ZP

Part #	Anchor Dia x Length mm	Drill Hole Dia mm	Box Quantity
41525220	6 x 25	8	100
41525230	8 x 30	10	100
41525235	10 x 30	12	50
41525235B	10 x 30	12	500
41525260	12 x 50	15	50
41525270	16 x 65	20	25
41525280	20 x 80	25	25



ALL METAL DRIVE ANCHOR (METAL TAP-INS) ROUND HEAD

Part #	Anchor Dia x Length mm	Drill Hole Dia mm	Box Quantity
41545700	5 x 25	5	100
41545720	6.5 x 32	6.5	100
41545740	6.5 x 50	6.5	100



NYLON DRIVE ANCHOR (NYLON TAP-INS) ROUND HEAD

Part #	Anchor Dia x Length mm	Drill Hole Dia mm	Box Quantity
41545540	5 x 25	5	100
41545458	5 x 40	5	100
41545560	6.5 x 25	6.5	100
41545570	6.5 x 40	6.5	100
41545580	6.5 x 50	6.5	100



HEADLESS SCREW

Part #	Type	Thread Connection	Total Length mm	Box Quantity
41585080	M10/80mm	M10 x 30	80	100
41585100	M10/100mm	M10 x 30	100	100



3. Threaded Consumables

Threaded Rod, Nuts, Washers, Screws & Plugs

THREADED ROD

Part #	Diameter	Finish	Length
42RM06	M6	ZP & HDG & SS	3m
42RM08	M8	ZP & HDG & SS	3m
42RM10	M10	ZP & HDG & SS	3m
42RM12	M12	ZP & HDG & SS	3m
42RM16	M16	ZP & HDG & SS	3m
42RM20	M20	ZP & HDG & SS	3m



ROD COUPLERS

Part #	Diameter	Finish
42CM06	M6	ZP & HDG & SS
42CM08	M8	ZP & HDG & SS
42CM10	M10	ZP & HDG & SS
42CM12	M12	ZP & HDG & SS
42CM16	M16	ZP & HDG & SS
42CM20	M20	ZP & HDG & SS

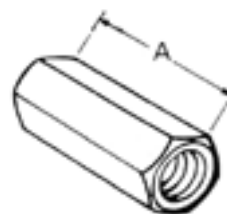

HEX NUTS

Part #	Diameter	Finish
42NHZM06	M6	ZP & HDG & SS
42NHZM08	M8	ZP & HDG & SS
42NHZM10	M10	ZP & HDG & SS
42NHZM12	M12	ZP & HDG & SS
42NHZM16	M16	ZP & HDG & SS
42NHZM20	M20	ZP & HDG & SS



FLAT WASHERS

Part #	Diameter	Finish
42WFZM06	M6	ZP & HDG & SS
42WFZM08	M8	ZP & HDG & SS
42WFZM10	M10	ZP & HDG & SS
42WFZM12	M12	ZP & HDG & SS
42WFZM16	M16	ZP & HDG & SS
42WFZM20	M20	ZP & HDG & SS



SPRING WASHERS

Part #	Diameter	Finish
42WSZM06	M6	ZP & HDG & SS
42WSZM08	M8	ZP & HDG & SS
42WSZM10	M10	ZP & HDG & SS
42WSZM12	M12	ZP & HDG & SS
42WSZM16	M16	ZP & HDG & SS
42WSZM20	M20	ZP & HDG & SS



COACH SCREWS/PLUGS

Part #	Diameter	Finish
41CS0850	M8 x 50	ZP
41CS1065	M10 x 65	ZP
41CSP1050	M10 x 50	Nylon
41CSP12060	M12 x 60	Nylon



FRAME ANCHOR

Part #	Description	Box Quantity
41560235	M10 x 80 C/W Plug	100
41560240	M10 x 100 C/W Plug	100



3. Threaded Consumables

Sets Screws, Cup Heads & Pan Pozis

METRIC COMMERCIAL HEX HEAD SET SCREWS ZP

Part #	Diameter	Finish
42S06010	M6 x 10 Set Screws	ZP
42S06020	M6 x 20 Set Screws	ZP
42S06025	M6 x 25 Set Screws	ZP
42S06030	M6 x 30 Set Screws	ZP
42S06040	M6 x 40 Set Screws	ZP
42S08020	M8 x 20 Set Screws	ZP
42S08025	M8 x 25 Set Screws	ZP
42S08030	M8 x 30 Set Screws	ZP
42S08040	M8 x 40 Set Screws	ZP
42S08050	M8 x 50 Set Screws	ZP
42S10020	M10 x 20 Set Screws	ZP
42S10025	M10 x 25 Set Screws	ZP
42S10030	M10 x 30 Set Screws	ZP
42S10040	M10 x 40 Set Screws	ZP
42S10050	M10 x 50 Set Screws	ZP
42S10065	M10 x 65 Set Screws	ZP
42S12025	M12 x 25 Set Screws	ZP
42S12030	M12 x 30 Set Screws	ZP
42S12040	M12 x 40 Set Screws	ZP
42S12050	M12 x 50 Set Screws	ZP
42S12060	M12 x 60 Set Screws	ZP
42S12075	M12 x 75 Set Screws	ZP

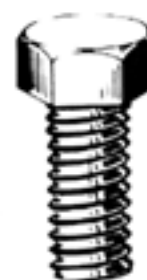

METRIC CUP HEAD MILD STEEL BOLTS & NUTS ZP

Part #	Diameter	Finish
42BN06025	M6 x 25 Cup Head	ZP
42BN08025	M8 x 25 Cup Head	ZP
42BN08040	M8 x 40 Cup Head	ZP
42BN10025	M10 x 25 Cup Head	ZP
42BN10030	M10 x 30 Cup Head	ZP



METRIC PAN HEAD METAL THREAD SCREWS POZI DRIVE ZP

Part #	Diameter	Finish
42B06016	M6 x 16 Pan Pozis	ZP
42B06020	M6 x 20 Pan Pozis	ZP
42B06025	M6 x 25 Pan Pozis	ZP
42B06030	M6 x 30 Pan Pozis	ZP
42B08025	M8 x 25 Pan Pozis	ZP
42B08030	M8 x 30 Pan Pozis	ZP
42B08040	M8 x 40 Pan Pozis	ZP
42BC05012	M5 x 12 Csk Pozis	ZP
42BC06016	M6 x 16 Csk Pozis	ZP



**Other sizes are available on request.
Also Available in HDG & STAINLESS STEEL FINISH.**

3. Threaded Consumables

Tek Screws and Drill Bits

SELF DRILLING FOR METAL CLASS 3

Part #	Description	Size
183308012	Hex Head	8-18x12
183310016	Hex Head	10-16x16
183310025	Hex Head	10-16x25
183312020	Hex Head	12-14x20
183312532	Hex Head Series 500	12-24x32
183310116	Hex Head w/-Neo Washer	10-16x16
183308412	Button Head	8-18x12
183310216	Wafer Head	10-16x16



SELF DRILLING FOR METAL CLASS 2

Part #	Description	Size
183208312	Button Head	8-18x12
183208320	Button Head	8-18x20
183210216	Wafer Head	10-16x16



SELF DRILLING FOR TIMBER CLASS 3

Part #	Description	Size
183T312025	Hex Head	12-11x25

HSS DRILL BITS

Part #	Description	Size
15DE30	Double End	No30
15DE20	Double End	No20
15DE11	Double End	No11
15STUB30	Stub	No30
15STUB20	Stub	No20
15STUB11	Stub	No11
15JOB6.5	Jobber	6.5mm
15JOB10.5	Jobber	10.5mm



SDS MULTI-FIT MASONRY DRILL BITS

Part #	Description	Size
152D050110	SDS Multi-Fit	M5 x 110
152D065110	SDS Multi-Fit	M6.5 x 110
152D080160	SDS Multi-Fit	M8 x 160
152D100160	SDS Multi-Fit	M10 x 160
152D120160	SDS Multi-Fit	M12 x 160
152D150160	SDS Multi-Fit	M15 x 160
152D160160	SDS Multi-Fit	M16 x 160
152D200200	SDS Multi-Fit	M20 x 200
152D250250	SDS Multi-Fit	M25 x 250



3. Threaded Consumables

Pop Rivets Other sizes and materials are available.

ALUMINIUM RIVETS WITH STEEL STEM

Part #	Description	Size
06AS402	3.2mm dia x 3.2 max grip	4-2
06AS403	3.2mm dia x 4.8 max grip	4-3
06AS404	3.2mm dia x 6.4 max grip	4-4
06AS604	4.8mm dia x 6.4 max grip	6-4



ALUMINIUM SEALED RIVET

Part #	Description	Size
06TA4-3	3.2mm dia x 4.8 max grip	4-3
06SR01-4812	4.8mm dia x 8.0 max grip	6-5

STEEL RIVETS WITH STEEL STEM

Part #	Description	Size
06SSP402	3.2mm dia x 3.2 max grip	4-2
06SSP403	3.2mm dia x 4.8 max grip	4-3
06SSP404	3.2mm dia x 6.4 max grip	4-4
06SSP504	4.2mm dia x 6.4 max grip	5-4
06SSP604	4.8mm dia x 6.4 max grip	6-4

S/STEEL RIVETS WITH S/STEEL STEM

Part #	Description	Size
06STST402	3.2mm dia x 3.2 max grip	4-2
06STST403	3.2mm dia x 4.8 max grip	4-3
06STST404	3.2mm dia x 6.4 max grip	4-4
06STST604	4.8mm dia x 6.4 max grip	6-4

THREADED ROD CUTTER

- 10mm Rod Cutters can cut 6mm, 8mm, and 10mm threaded mild steel rod with little effort.
- No damage to thread after cutting.
- Easy to operate and quick cutting time.
- Body weighs 4.5kg.
- Overall length 765mm.
- 12mm Rod Cutters also available.
- Replacement dies available.

Part #	Description
42RCM10	Rod Cutter M10
42RCM12	Rod Cutter M12
42RDM06	M6 Die For Rod Cutter
42RDM08	M8 Die For Rod Cutter
42RDM10	M10 Die For Rod Cutter
42RDM12	M12 Die For Rod Cutter



DROP-IN SETTING TOOL

Part #	Description	Box Quantity
41243740	M8	1
41230935	M10	1
41243743	M12	1
41243744	M16	1
41243745	M20	1



*Delivering a Quality, Competitive Construction
Support System on Time on Budget*



11 Cowcher Place Belmont WA 6104
Phone: (08) 6278 7500 Fax: (08) 6278 7599
Web Site: www.caddyindustrial.com.au
Email: sales@caddyindustrial.com.au